



## A Framework for Optimizing Process Parameters in Direct Metal Laser Sintering (DMLS) using Artificial Neural Network (ANN)

---

Mallikharjun Marrey, Ehsan Malekipour, Hazim El-Mounayri and  
Eric J Faierson

EasyChair preprints are intended for rapid  
dissemination of research results and are  
integrated with the rest of EasyChair.

April 14, 2019

# A Framework for Optimizing Process Parameters in Direct Metal Laser Sintering (DMLS) using Artificial Neural Network (ANN)

Mallikharjun Marrey<sup>a</sup>, Ehsan Malekipour<sup>a, †</sup>, Hazim El-Mounayri<sup>a</sup>, Eric J. Faierson<sup>b</sup>

<sup>a</sup>Collaborative Additive Manufacturing Research Initiative (CAMRI), Purdue School of Engineering and Technology, Indianapolis, 46202, USA

<sup>b</sup>Quad City Manufacturing Laboratory-Western Illinois University, Rock Island, IL 61201, USA

## Abstract

Direct Metal Laser Sintering (DMLS) is a metal additive manufacturing process, which can build parts with any complexity from a wide range of metallic materials. Research in DMLS predominantly focuses on the impact of few parameters on the ultimate properties of the printed part. The lack of a systematic approach to optimizing the process parameters for a better performance of given material results in a sub-optimal process. This process needs a comprehensive study of all the influential parameters and their impact on the mechanical and microstructural properties of a fabricated part. Furthermore, there is a need to develop a quantitative system for mapping the material properties and process parameters with the ultimate quality of the fabricated part to achieve improvement in the manufacturing cycle as well as the quality of the final part produced by the DMLS process. To address the aforementioned challenges, this research proposes a framework to optimize the process for Ti-6Al-4V material. This framework characterizes the influence of process parameters on the microstructure and mechanical properties of the fabricated part using a series of experiments. These experiments study the significance of process parameters and their variance as well as study the microstructure and mechanical properties of fabricated parts by conducting tensile, impact, hardness, surface roughness, and densification tests, and ultimately obtain the optimum range of parameters. This would result in a more complete understanding of the correlation between process parameters and part quality. Furthermore, these experiments provide the required data needed to develop an Artificial Neural Network model to optimize process parameters (for achieving the desired properties) and estimate fabrication time.

**Keywords:** Additive manufacturing; selective laser sintering; DMLS; artificial neural network (ANN); optimization framework; parameter optimization; sensitivity analysis

## 1. Introduction

DMLS is the most widely used additive manufacturing technology for metal printing and functional parts [1]. A wide range of metallic powder can be used as raw material for this process [2]. As with any other additive technology, DMLS fabricates parts directly from 3D CAD data (STL file) and eliminates the use of expensive tooling [3, 4]. STL file slices the overall part into many layers with respect to the layer thickness and a laser beam sinters each layer. Unlike the Selective Laser Melting (SLM) process, where the powder is completely melted down to form a homogeneous part, DMLS partially melts the material (sinter the powder) layer-by-layer at the molecular level [5]. The schematic diagram in Fig. 1 shows the overall process of the DMLS process [6]. The 3D printer machine consists of a supply station for the metal powder and a sintering unit. A laser selectively sinters the powder with respect to the layer geometry along a prescribed pattern. After sintering of a layer, the powder dispenser platform moves upward a distance equals to the thickness of a layer to supply the material required for printing a new layer and a recoater arm or a roller transfers the material powder to the sintering zone. The same process continues until the fabrication of the last layer [7].

Due to the ability of DMLS to produce homogeneous parts with high strength alloys and allowable free-form fabrication [4], it has found applications in various sectors such as aerospace, defense, medical etc. [8, 9]. Aerospace industry widely employs the DMLS process because of advantages such as timesaving and the ability to produce functional assemblies [8, 10]. A wide range of metals such as Inconel 625, Inconel 718, 316L stainless steel, cobalt chrome,

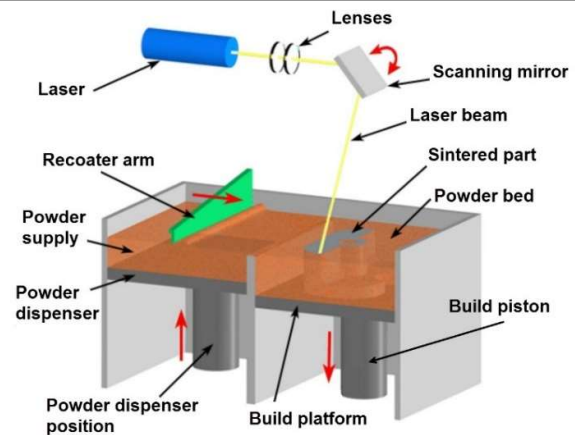

Fig. 1. A schematic diagram of direct metal laser sintering (DMLS) process [6]

aluminum, titanium, and many alloys including Ti-6Al-4V are excellent materials for aerospace industry, which are offering a significant cost and weight reduction [11, 12].

The DMLS process has been employed in various industries however it still suffers from some process drawbacks. To overcome these drawbacks, the research in the DMLS process nowadays concentrated on the impact detection of few parameters on the ultimate properties of the printed part [1, 5, 10, 13-18]. The ultimate goal is to develop a system linking manufacturing process, material

<sup>†</sup> Corresponding author

E-mail address: [emalekip@purdue.edu](mailto:emalekip@purdue.edu)

properties, and the ultimate quality of a fabricated part to optimize the process parameters. Fulfilling this objective needs a comprehensive study on all the influential parameters with their significance on the mechanical and microstructural properties of a fabricated part. Furthermore, it needs to develop a quantitative system for mapping material property and process parameters to achieve improvement in the manufacturing cycle and quality control of the parts produced by DMLS process.

More than fifty parameters exist and have an influence on the ultimate quality of the product [19-21]. Scholars classify the process parameters into different groups [20, 22]. In one approach, Malekipour et al. classified the parameters into three main categories. The first category is pre-processed parameters including environmental conditions such as an inert gas, oxygen level, ambient temperature, powder specifications, and machine capabilities/limitations. The second category is the controllable parameters, which include process parameters, namely, laser specifications and scan strategy, and some few manufacturing specifications such as layer thickness. The last category includes the post-processed parameters, which quantify the ultimate quality of the fabricated part such as the yield strength, fatigue resistance, etc. [22]. Van Elsen named some of the important parameters in each classification. He mentioned that the powder specifications and deposition include morphology, the surface roughness of the generated grains, particle size distribution, and the deposition system of powder on to the bed. The laser specifications include spot size, wavelength, peak power, mode of the laser, and laser pulse length. The process parameters include part placement, scan strategy, build direction, laser power, scan speed, scan strategy, layer thickness, preheating temperature, hatch distance, and energy density [23].

The aforementioned parameters influence the process and the fabrication cost [20]. For instance, the process utilizes Argon instead of Helium as an environment for Ti-6Al-4V because Helium is 3 to 4 times more expensive than Argon [23]. However, previous literature shows that among all the factors affecting the sintered part few parameters, namely, laser power, scan speed, hatch spacing, layer thickness, beam diameter, and preheating temperature have a tremendous impact on mechanical efficiency, economy, and ultimate quality of the entire sintering process [5, 9, 18, 24].

The objectives of the study are first, to determine the optimal range of the process parameters and the way that different parameters affect the microstructure, densification, and mechanical properties of the printed part. Second, to specify the sensitivity of different parameters and identify which ones affect the overall performance the most, within the optimal range. Third, to optimize these parameters to be able to print a part with a better ultimate quality; and finally, to develop a system for quality control, and an intelligent network for suggesting optimized process parameters.

## 2. The current state of knowledge and gaps

Although Laser Sintering (LS) technology has significantly developed and is employed in different industries, many challenges and issues still remain. These challenges hinder the process repeatability, consistency, and stability of the process. Several research works have studied the influence of process parameters on quality for different materials and machines; however, it has proven very difficult to control all aspects of the process or evaluate the

collective influence of all the parameters on the properties of a fabricated part.

Some previous work studied the effect of different process parameters on the ultimate surface quality. Yasa et al. [2] studied the staircase effect for nickel-based alloy parts manufactured by the DMLS process. This research took the total waviness as the objective function and developed a predictive model. This model considered a few process parameters to develop it. Related to this work, Arasu et al. [1] and Hanzl et al. [3] studied the surface roughness of a part printed by the SLS process and conducted Analysis of Variance (ANOVA) to obtain the optimal parameter settings to achieve a better final surface finish. Similarly, Read et al. [25] used the response surface method to analyze various process parameters statistically and developed optimal parameters for surface roughness. This method has the advantage to consider a greater number of process parameters and conduct statistical analysis with a smaller number of experiments to print. Furthermore, Fox et al. [14] studied the effect of the process parameters on the surface roughness of overhanging structures in a powder-bed fusion process. This work covers a range of overhang angles and process parameters to determine a relationship between process parameters, the angle of the overhanging surface, and the surface roughness.

There is more research, which focused on other aspects of the process. Sufiiarov et al. [26] studied the effect of the layer thickness on the parts printed by the SLM process. This study found that the microstructure, tensile strength, and elongation at the break depending on the layer thickness. Asgari et al. [9] used different process parameters available in a DMLS system, such as laser power, scan speed, hatch distance, and laser offset distance for three different AlSi10Mg samples in 200 C with different surface roughness levels. This work employed Optical Microscopy (OM) and Scanning Electron Microscopy (SEM) techniques to study the microstructure of the printed samples. Moreover, Elsen [23] developed a genetic algorithm to perform variance analysis to study the complexity of the SLM process for a limited number of process parameters. The proposed methodology presented the synergistic possibilities of the mass-spring-damper system to optimize the density of fabricated parts by varying the selected parameters.

Konecna et al. [17] printed Ti-6Al-4V specimens by the SLM process in different orientations to determine the crack propagation and presented a stress intensity threshold for the growth of long cracks. In another study, Zhao et al. [27] evaluated the heat transfer and residual stress evolution in the parts produced by the DMLS process and developed a numerical model by using COSMOL multi-physics environment for Ti6Al-4V. This study performed a thermo-mechanical simulation to study the change of residual stresses of a single layer, and physics and temperature of melt pool, which give a clear understanding of the thermo-mechanical evolution of a laser sintered additive process.

Hofland et al. [28] studied the mechanical properties of PA12 parts printed by the SLS process. In this work, they printed 480 tensile samples with 17 different sets of the process parameter. The part properties selected as output are a tensile strength, tensile modulus, elongation at the break, and part density. Monte Carlo performed a simulation to determine the linear correlation between the coefficients and the sensitivities of the process parameters. This simulation derived some interesting parameters properties, which influence the ultimate mechanical properties of the printed parts. Finally, Munguia et al. [29] employed a neural network-based model

for the estimation of the build time in the SLS process as well as a MATLAB simulation to validate the results with the existing cost estimation models.

However, these research studies focused on identifying the influence of few process parameters, predominantly laser specifications, on the surface quality or selective mechanical properties of the printed part; few research works studied the correlation between the parameters and the ultimate properties of the printed part. Optimizing the machine setting by controlling of the aforementioned parameters is a prerequisite for a near flawless fabrication process. Furthermore, there is a lack of a consistent system considering/optimizing all the controllable parameters and mapping the process, material, and parameters and ultimate properties of the fabricated parts. The major contribution of this work is to examine the effect of a set of parameters instead of the effect of their individual impact on the selected properties of a fabricated part. This will help to fill the existing gap for development of a standardized system, which considers all contributing and controllable factors starting from the design phase to the end-product services and testing the fabricated parts for compliance.

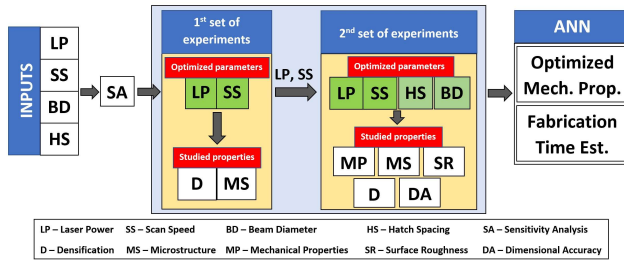

Fig. 2. Proposed framework and corresponding workflow for developing ANN model

### 3. Methodology and results

Researchers have been studying the influence of every contributing parameter on the ultimate properties of a fabricated product. However, a collective system, which considers all the controllable parameters, is missed. The framework introduced in this paper will help in achieving a comprehensive understanding of the process and the importance of each individual parameters from the selected ones setting up the levels for next step. Then, this system conducts two sets of Design of Experiments (DOE) in the next steps and tests the consequent properties of the fabricated parts. The system will finally employ the acquired results to train an intelligent system suggesting the optimized process parameters for obtaining a better ultimate quality as well as estimating fabrication time of the parts printed by the sintering process with the Ti-6Al-4V material. The following sections explain the details of the proposed framework.

### 3.1. Material properties

Ti-6Al-4V is the material considered for this research, which is an alloy consisting of alpha-beta phase. Ti-6Al-4V has excellent properties, such as a corrosion resistance, lightweight, and a high strength at low to moderate temperatures [30]. Medical devices, aircraft structural components, automotive parts, the engine components of aircraft turbine, and marine applications are some of the many applications where this alloy is used [9, 31]. Depending on the field of application, the composition of the alloy (Table 1) is controlled to achieve the required properties (Table 2). The amount of oxygen and nitrogen in the alloy plays an important role in obtaining the ultimate strength and mechanical properties.

Production of alloy with a higher strength requires higher concentrations of nitrogen and oxygen. Conversely, lower concentrations of nitrogen and oxygen increase the ductility, fracture toughness, stress corrosion resistance, and resistance to crack growth [32].

### 3.2. Design of specimen

This work employs the ASTM E8 standard specimen (Table 3) [33] to test the tensile properties. We extend the specimen length on both sides to perform more mechanical testing, namely, hardness, and impact as well as to study the microstructure more. The quality and precision of the specimens are vital to get some more accurate metallographic analysis. Fig. 3 shows the designed specimen, which includes three sections for the tensile testing specimen (the middle section), the impact test (the left section), and the hardness test (the right section) of the specimen. All the dimensions are modified according to the ASTM standards.

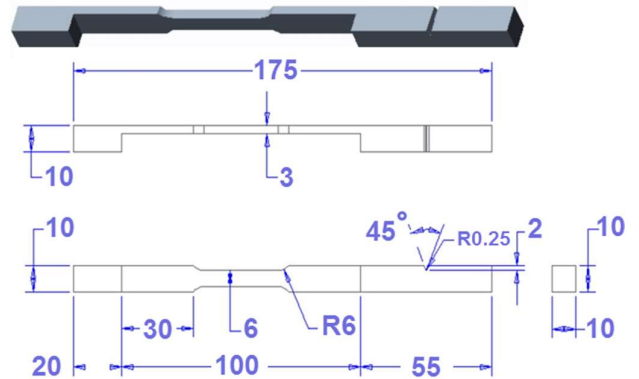

Figure 3: Designed specimen

### 3.3. Sensitivity analysis

Sensitivity analysis (SA) quantifies the correlation between the given model and its input parameters [34]. The main objective of conducting SA are to understand (1) which parameters require additional research for strengthening the knowledge base, thereby reducing output uncertainty; (2) which parameters are irrelevant and can be eliminated from the final model; (3) which inputs contribute most to output variability; and (4) which parameters are most highly correlated with the output [34].

Table 1. Chemical Specification [30]

	Ti-6Al-4V, Typ.	Ti-6Al-4V, Req.*	Ti-6Al-4V, Req.**
Aluminum, Al	6%	5.5-6.75%	5.5-6.75%
Vanadium, V	4%	3.5-4.5%	3.5-4.5%
Carbon, C	0.03%	<0.1%	<0.08%
Iron, Fe	0.1%	<0.3%	<0.3%
Oxygen, O	0.15%	<0.2%	<0.2%
Nitrogen, N	0.01%	<0.05%	<0.05%
Hydrogen, H	0.003%	<0.015%	<0.015%
Titanium, Ti	Balance	Balance	Balance

\*ASTM F1108 (cast material) \*\*ASTM F1472 (Wrought material)

Table 2. Mechanical properties [30]

	Ti-6Al-4V, Typ.	Ti-6Al-4V**	Ti-6Al-4V***
Yield Strength	950 MPa	758 MPa	860 MPa
Ult. Tensile Strength	1020 MPa	860 MPa	930 MPa
Elongation	14%	>8%	>10%
Reduction of Area	40%	>14%	>25%
Fatigue strength*	10e6 cycles	-	-
Rockwell Hardness	33 HRC	-	-
Modulus of Elasticity	120 GPa	-	-

\*After Hot Isostatic Pressing; \*\*ASTM F1108 (cast material);

\*\*\*ASTM F1472 (Wrought material)

Table 3. Tensile testing specimen, ASTM E8/E8M 13a [33]

Dimensions for the subsize specimen (6 mm [0.250 in.] wide) (mm [in.])	
G Gauge length	25.0 0.1 [1.000 0.003]
W Width	6.0 0.1 [0.250 0.005]
T Thickness	Maximum 6 mm
R Radius of fillet, min	6 [0.250]
L Overall length, min	100 [4]
A Length of reduced section, min	32 [1.25]
B Length of grip section, min	30 [1.25]
C- Width of grip section, approximate	10 [0.375]

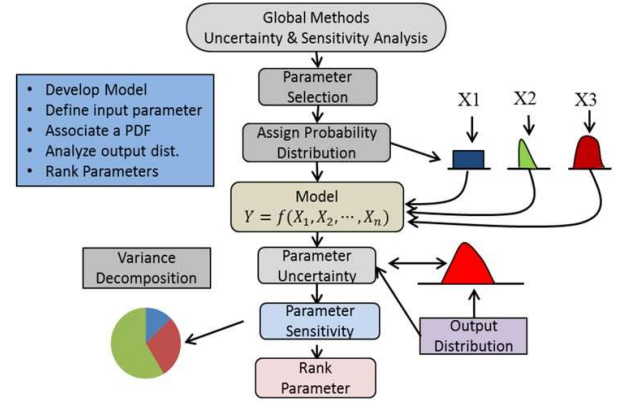
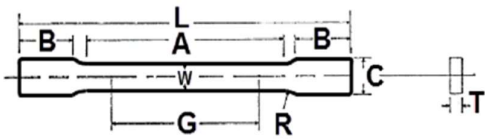

Fig. 4. Schematic for global sensitive analysis [35]

The laser power, scan speed, layer thickness, beam diameter, and the hatch spacing are commonly cited in the literature as the crucial controllable parameters in the DMLS process influencing the ultimate quality of the fabricated part [21, 28]. The correlation between the above parameters with volumetric energy density is shown in equation 1 [36]. Employing SA within the working range of parameters in this work, the sensitivity of each parameter in the range is calculated which guides in selecting the levels and their distribution for the DOE.

$$ED = \frac{P}{S * V * t} \quad (1)$$

where P is laser power, S is hatch spacing, V is scan speed, and t is layer thickness, which is set to a constant value of 30  $\mu\text{m}$  in this research. Fig. 4 shows the schematic process of the global SA employed by MATLAB [37]. The SA results evidently show the scan speed as the most sensitive parameter, which drastically changes the energy applied per volume and might influence the ultimate properties of the fabricated part predominantly [36]. In a similar way, the laser power and hatch spacing also have a considerable effect. The effect of layer thickness is not calculated as it is set to a constant value throughout this research. Fig. 5 shows the values of the total global sensitivity coefficient obtained by SA.

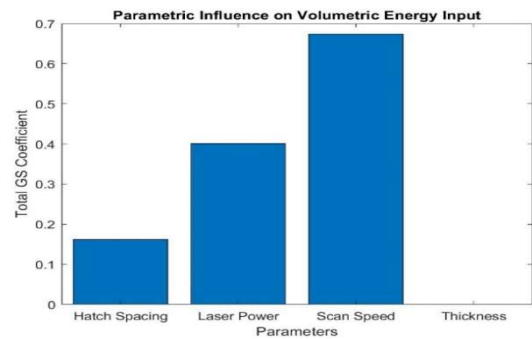

Fig. 5. Total Global Sensitivity (GS) Coefficient

Previous literature also confirmed the significant influence of laser power and scan speed, as two main parameters that affect the energy transferred to the powder, on the ultimate quality of the

printed part. D. Gu and Y. Shen [8] conducted experiments with different combination values of laser power and scan speed on stainless steel 316L with the layer thickness of 20  $\mu\text{m}$ . Their study shows the parameters generates four different melting status shown in Fig. 6.

In case I, which is called the no-melting zone, the energy density is insufficient to melt the powder leaving the powder in its initial state. In case II, a medium laser power scans the powder with a low scan speed leading to the partially melted powder. This phase forms coarsened balls after crystallization, which is the first form of the balling phenomenon. A high laser power and high scan speed melt the powder with balling phenomenon along the scanned pattern in the form of thin cylindrical lines in case III. Complete melting occurs in the case of IV as the high laser power forms a solid surface by continuous lines of fully melted powder along the scan paths.

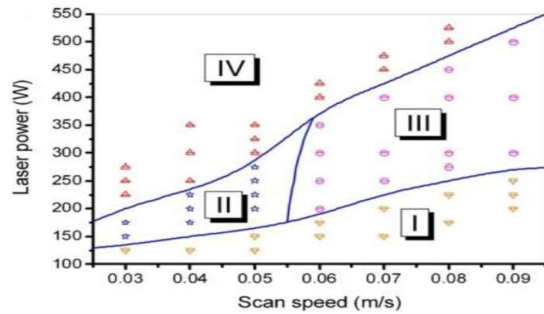

Fig. 6. The dependency of structure on procedural parameters [8]

### 3.4. Design of experiments

This work employs the Taguchi method to design the experiments. Taguchi method is a statistical method, which designs experiments using Orthogonal Array (OA) technique to eventually improve the quality of a manufacturing process [23]. The OA technique converts the parameter design values to S/N ratio and calculates the design robustness [15]. To improve the product quality, the quality characteristics must deviate as little as possible from the target value. OA is a systematic and statistical way of testing interactions between control factors. It provides a uniformly distributed set of experiments, which covers all the paired combinations of the variables [31] instead of the full factorial analysis, which is unnecessary because it requires a huge amount of material, specimens fabrication, and a great deal of time.

Table 4. Control factors and levels for DOE

Factor	Level values	Levels
Laser Power, W	100, 125, 150, 175	4
Scan Speed, mm/sec	600, 800, 1000, 1200	4

Table 5. Taguchi method of DOE

No.	Laser Power (W)	Scan Speed (mm/s)	No.	Laser Power (W)	Scan Speed (mm/s)
1	100	600	9	150	600
2	100	800	10	150	800
3	100	1000	11	150	1000
4	100	1200	12	150	1200
5	125	600	13	175	600
6	125	800	14	175	800
7	125	1000	15	175	1000
8	125	1200	16	175	1200

Taguchi method requires a three-step procedure, namely, system design, parameter design, and tolerance design. First, it selects the control factors, namely, process parameters and their designated levels, namely, values of the process parameters. Table 4 shows the parameters, namely, the laser power and scan speed, and the assigned values for each parameter selected for this work based on the literature [13, 26, 36, 38, 39]. In this research, there will be two sets of experiments corresponding to the selected parameters. The first set of experiments, shown in Table 5, prints a 10 mm x 10 mm x 5 mm samples considering merely the laser power and scan speed, while hatch spacing and beam diameter are kept fix at their machine default values. The layer thickness is also set to a constant value of 30  $\mu\text{m}$  throughout the work. Taguchi L16 OA is used for designing first set of experiments. This set of experiment studies the microstructure, porosity, and densification of the printed samples to map them onto the laser power and scan speed. This study ultimately helps to obtain the optimal range of energy density for maximum densification. The second set of experiments will be designed by Taguchi method considering the knowledge of an optimum range of energy density which result in maximum density values, obtained from the first run, to drive the optimum values for the parameters with a decisive impact on the ultimate properties of a fabricated part. The level values of parameters are derived from the results of first set of experiments. In this phase, 64 experiments will be conducted (L64 OA). This set of experiments will study the effect of the laser power, scan speed, beam diameter, and hatch spacing on the porosity and ultimate mechanical properties of printed samples. Fig. 3 shows the designed sample for running the second set of experiments. The laser power and scan speed will vary inside the optimum range derived from set 1 in the previous phase. The results and data acquired from second set will be used in developing ANN.

### 3.5. Mechanical properties

As Fig. 7 shows, a series of tests measure the mechanical properties and characteristics of the printed samples acquired by DOE. Various mechanical tests, namely, tensile, hardness, and impact investigate the mechanical characteristics of the fabricated product including surface finish, residual stresses, porosity, microstructure, and densification. The first set of samples studies the effect of a limited number of process parameters, namely, laser power and scan speed on the microstructure, porosity and density values for the samples printed by Ti6Al-4V, using SEM and Archimedes principle. The second set studies the aforementioned

mechanical properties of the printed samples to optimize a wider range of process parameters.

ANOVA employs the data acquired from the previous sets of experiments for data analysis, variance analysis, and ultimately helps in designing the Neural Network (NN) with the capability of intelligent suggestion of the process parameters. The next section provides more details about this approach.

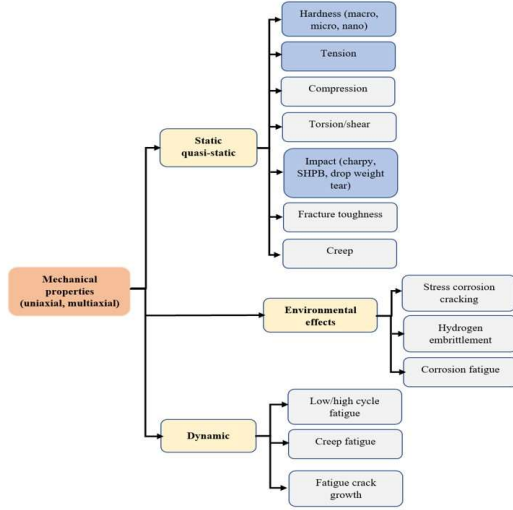

Fig. 7. Mechanical properties summary

### 3.6. Data analysis

#### 3.6.1. Signal/noise ratio and analysis of variance (ANOVA)

The signal/noise (S/N) is a method of variability measurement of the manufacturing process, which evaluates the process parameters at all individual levels ensuring the resulting optimum process conditions are robust and stable, meaning that the parameters minimize the process variation. The following equations calculate the three S/N ratios. Eq. 2 shows the lower-the-better (such as surface roughness), Eq. 3 shows the higher-the-better (such as mechanical strength), and the Eq. 4 shows the nominal the better (such as the dimension) [15, 25].

$$\frac{S}{N} = -10 * \log_{10} \left( \frac{1}{n} \sum_{i=1}^n Y_i^2 \right) \quad (2)$$

$$\frac{S}{N} = -10 * \log_{10} \left( \frac{1}{n} \sum_{i=1}^n \frac{1}{Y_i^2} \right) \quad (3)$$

$$\frac{S}{N} = -10 * \log_{10}(s^2) \quad (4)$$

Where n is the number of measurements and  $Y_i$  is the observed performance characteristic value and s is the standard deviation of the responses for the given factor level combination.

After the calculation of S/N value, a method called Analysis of Variance (ANOVA) statistically evaluates the significance of the control factors (i.e. process parameters in our work) and their influence on the experimental results (mechanical properties). ANOVA studies the variance of properties with the levels of parameters by employing the data available after material and mechanical testing [31]. The provided graphs and distribution

charts will describe the variance of properties within the tested range of levels; thus, they will obtain the optimal range of the values for Ti-6Al-4V in the DMLS process. This will complete the correlation between the material and process-properties for the DMLS process, which will guide in the development of a ANN system.

### 4. Future Work: Neural Network method

There are two main methods for modeling the manufacturing process: physics-based and data-driven modeling. The physics-based modeling technique analyzes the manufacturing process from a physical point of view. However, this traditional analytical modeling method is not always suitable to model some modern complex manufacturing processes, such as AM, due to the number of process variables and the non-linear nature of the problem.

Another modeling method is empirical modeling, which employs experimental data and statistical theory [31]. Many applications in manufacturing engineering successfully implemented the ANN as a good empirical modeling method. This work employs the acquired data from the experimental sets to model the process by creating a correlation between the process parameters and ultimate properties of the fabricated parts. To obtain this objective, ANN uses the acquired experimental data and the data provided by the framework to develop a predictive function for fabrication of parts in accordance with the desired requirements, namely, mechanical properties, microstructure, fabrication time, dimensional accuracy, and surface roughness. Furthermore, developing the ANN system will help to study the effect of other dynamic mechanical properties and environmental parameters on the DMLS process.

This work will employ the Feed-forward Artificial Neural Network (ANN) to model the process. Fig. 8 shows the schematic architecture of this ANN. Furthermore, Fig. 9 shows the ANN architecture and the different inputs and outputs, which will be used by this project to train the model.

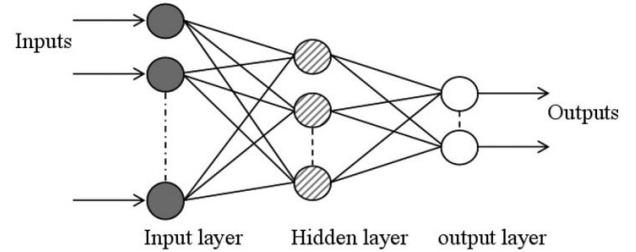

Fig. 8. Schematic diagram of multilayer feed-forward NN Architecture [53]

The trained ANN system in this project may integrate into an online monitoring and control (OMC) systems in the DMLS process. A plentiful research nowadays has focused on the development of OMC systems [40-45] to avoid/diminish the defects and abnormalities generated during the fabrication process and use the AM process for mass customization [21, 22, 4648]. Monitoring and control of the thermal specifications and thermal evolution of any inherently thermal AM process is crucial as it affects significantly

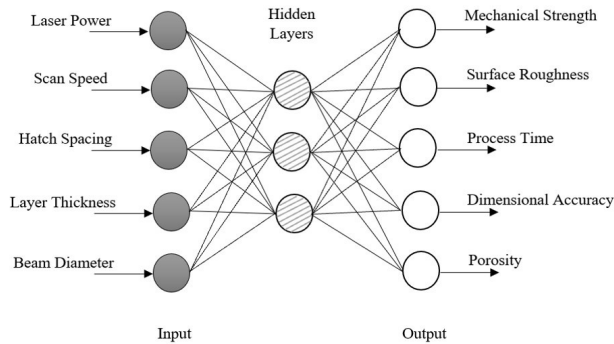

Fig. 9. The schematic ANN architecture of this research

the microstructure and ultimate mechanical properties of a fabricated part [49-51]. Nowadays, most vendors try to handle the frequent thermal abnormalities of the fabricated parts such as distortion by designing some temporary support structures to be able to facilitate the conduction during the fabrication process as well as strengthening the structure. However, scholars have tried to reduce the fabrication time and material by designing the topology-optimized support structures [52], the fabricated parts still need a significant work for post-processing. Thus, it seems that controlling the process parameters real-time is the ultimate way to overcome the current drawbacks in any inherently thermal AM process including the DMLS process. The functions trained by ANN in this project can considerably improve/complete a control system to adjust the process parameters real-time, improve the ultimate quality of a fabricated part, and reduce the post-processing operations.

## 5. Conclusion

The study presents a framework for the optimization of direct metal laser sintering process based on improving our knowledge of the correlation between the manufacturing process, material properties, and the ultimate quality of the fabricated part with the process parameters. The proposed framework supports/achieves several objectives. It allows us to measure the influence of laser power and scan speed on the microstructure and porosity of a fabricated part. Second, it helps obtain the optimal range of the energy density for a maximum densification. Third, it provides a way to measure the influence and sensitiveness of laser power, scan speed, hatch spacing and beam diameter within the optimal range of energy density, ultimately resulting in the optimization of these parameters. Fourth, it leverages the acquired data to achieve a clear understanding of the effect of the parameters on the mechanical properties, residual stresses, surface roughness, dimensional accuracy, and microstructure development. Finally, it helps in the development of an intelligent neural network for parameter suggestion and build-time estimations.

## 6. Acknowledgement

This research was supported by the CAMRI Research Laboratory. We would also like to show our gratitude to our colleagues from the Quad City Manufacturing Laboratory, who provided insight, expertise, and facilities for the experimental studies that greatly assisted the research, although they may not agree with all the interpretations/conclusions of this paper.

## References

- [1] Arasu, I., et al., Optimization of surface roughness in selective laser sintered stainless steel parts. Vol. 6. 2014. 2993-2999.
- [2] Yasa, E., et al., A Study on the Stair Stepping Effect in Direct Metal Laser Sintering of a Nickel-based Superalloy. *Procedia CIRP*, 2016. 45: p. 175178.
- [3] Hanzl, P., et al., The Influence of Processing Parameters on the Mechanical Properties of SLM Parts. Vol. 100. 2015.
- [4] Dingal, S., et al., The application of Taguchis method in the experimental investigation of the laser sintering process. Vol. 38. 2008. 904-914.
- [5] Hardik Varia, B.G., A Review on Effect of Process Parameters on Surface Quality and Properties of Parts Realized by Selective Laser Sintering Process. *International Journal on Recent and Innovation Trends in Computing and Communication (IJRITCC)*, 2017: p. 45-51.
- [6] Custompart.net: 'Direct Metal Laser Sintering'. [cited 2018 June 25]; Available from: <http://www.custompartnet.com/wu/direct-metal-lasersintering>.
- [7] Verma, A., P.S. Tyagi, and K. Yang, Modeling and optimization of direct metal laser sintering process. Vol. 77. 2014.
- [8] Gu, D. and Y. Shen, Processing conditions and microstructural features of porous 316L stainless steel components by DMLS. *Applied Surface Science*, 2008. 255(5, Part 1): p. 1880-1887.
- [9] Mohammadi, M. and H. Asgari, Achieving low surface roughness *AlSi10Mg200C* parts using direct metal laser sintering. *Additive Manufacturing*, 2018. 20: p. 23-32.
- [10] Calignano, F., et al., Influence of process parameters on surface roughness of aluminum parts produced by DMLS. *The International Journal of Advanced Manufacturing Technology*, 2013. 67(9): p. 2743-2751.
- [11] DMLS.com. DMLS applications. [cited 2018 10/01]; Available from: <http://dmls.com/dmls-applications>.
- [12] Stratasys. Direct metal laser sintering materials. [cited 2018 10/01]; Available from: <https://www.stratasysdirect.com/materials/direct-metal-lasersintering>.
- [13] Gong, H., et al., Defect Morphology of Ti-6Al-4V Parts Fabricated by Selective Laser Melting and Electron Beam Melting. 2013.
- [14] Fox, J.C., S.P. Moylan, and B.M. Lane, Effect of Process Parameters on the Surface Roughness of Overhanging Structures in Laser Powder Bed Fusion Additive Manufacturing. *Procedia CIRP*, 2016. 45: p. 131-134.
- [15] Kumar, N., H. Kumar, and J.S. Khurmi, Experimental Investigation of Process Parameters for Rapid Prototyping Technique (Selective Laser Sintering) to Enhance the Part Quality of Prototype by Taguchi Method. *Procedia Technology*, 2016. 23: p. 352-360.
- [16] Delgado, J., J. Ciurana, and C.A. Rodriguez, Influence of process parameters on part quality and mechanical properties for DMLS and SLM with iron-based materials. *The International Journal of Advanced Manufacturing Technology*, 2012. 60(5): p. 601-610.
- [17] Konen, R., et al., Long Fatigue Crack Growth in Ti6Al4V Produced by Direct Metal Laser Sintering. Vol. 160. 2016. 69-76.
- [18] Pal, S., et al., The Effect of Post-processing and Machining Process Parameters on Properties of Stainless Steel PH1 Product Produced by Direct Metal Laser Sintering. Vol. 149. 2016. 359-365.
- [19] Yadroitsev, I., P. Bertrand, and I. Smurov, Parametric analysis of the selective laser melting process. *Applied Surface Science*, 2007. 253(19): p. 8064-8069.
- [20] Spears, T.G. and S.A. Gold, In-process sensing in selective laser melting (SLM) additive manufacturing. *Integrating Materials and Manufacturing Innovation*, 2016. 5(1): p. 2.
- [21] Malekipour, E. and H. El-Mounayri, Defects, Process Parameters and Signatures for Online Monitoring and Control in Powder-Based



- Additive Manufacturing, in *Mechanics of Additive and Advanced Manufacturing*, Volume 9. 2018, Springer. p. 83-90.
- [22] Malekipour, E. and H. El-Mounayri, Common defects and contributing parameters in powder bed fusion AM process and their classification for online monitoring and control: a review. *The International Journal of Advanced Manufacturing Technology*, 2018. 95(1): p. 527-550.
- [23] Van Elsen, M., Complexity of selective laser melting : a new optimisation approach. 2007.
- [24] Ruban, W., et al., Effective process parameters in selective laser sintering. *International Journal of Rapid Manufacturing*, 2014. 4(2-4): p. 148-164.
- [25] Read, N., et al., Selective laser melting of AlSi10Mg alloy: Process optimisation and mechanical properties development. Vol. 65. 2015. 417-424.
- [26] Sufiiarov, V.S., et al., The Effect of Layer Thickness at Selective Laser Melting. *Procedia Engineering*, 2017. 174: p. 126-134.
- [27] Zhao, X., et al., Numerical modeling of the thermal behavior and residual stress in the direct metal laser sintering process of titanium alloy products. *Additive Manufacturing*, 2017. 14: p. 126-136.
- [28] C. Hofland, E., I. Baran, and D. Wismeijer, Correlation of Process Parameters with Mechanical Properties of Laser Sintered PA12 Parts. Vol. 2017. 2017. 1-11.
- [29] Mungua, J., J. Ciurana, and C. Riba, Neural-network-based model for build-time estimation in selective laser sintering. *Proceedings of the Institution of Mechanical Engineers, Part B: Journal of Engineering Manufacture*, 2009. 223(8): p. 995-1003.
- [30] ARCAM EBM, S. Ti-6Al-4V Titanium Alloy. 09/21/2018]; Available from: <http://www.arcam.com/wp-content/uploads/Arcam-Ti6Al4VTitanium-Alloy.pdf>.
- [31] Chen, H., A process modelling and parameters optimization and recommendation system for binder jetting additive manufacturing process, in *Department of Mechanical Engineering 2016*, McGill University: Montreal
- [32] DebRoy, T., et al., Additive manufacturing of metallic components Process, structure and properties. *Progress in Materials Science*, 2018. 92: p. 112-224.
- [33] ASTM, Standard Test Methods for Tension Testing of Metallic Materials, in *E8 / E8M - 13*. 2013: ASTM International, West Conshohocken, PA.
- [34] Hamby, D.M., A review of techniques for parameter sensitivity analysis of environmental models. *Environmental Monitoring and Assessment*, 1994. 32(2): p. 135-154.
- [35] Nasir, B., Implementation of Sobols Method of Global Sensitivity Analysis to a Compressor Simulation Model, in *22nd International Compressor Engineering Conference*. 2014, Purdue e-Pubs: Purdue.
- [36] Thijs, L., et al., A study of the microstructural evolution during selective laser melting of Ti6Al4V. *Acta Materialia*, 2010. 58(9): p. 3303-3312.
- [37] Pianosi, F., F. Sarrazin, and T. Wagener, A Matlab toolbox for Global Sensitivity Analysis. *Environmental Modelling & Software*, 2015. 70: p. 80-85.
- [38] Vilaro, T., C. Colin, and J.D. Bartout, As-Fabricated and Heat-Treated Microstructures of the Ti-6Al-4V Alloy Processed by Selective Laser Melting. *Metallurgical and Materials Transactions A*, 2011. 42(10): p. 3190-3199.
- [39] Mertens, A., et al., Mechanical properties of alloy Ti6Al4V and of stainless steel 316L processed by selective laser melting: influence of out-of-equilibrium microstructures. *Powder Metallurgy*, 2014. 57(3): p. 184-189.
- [40] Amini, M. and S. Chang, A review of machine learning approaches for high dimensional process monitoring. 2018.
- [41] Amini, M. and S. Chang, Process Monitoring of 3D Metal Printing in Industrial Scale. 2018(51357): p. V001T01A035.
- [42] Amini, M. and S.I. Chang, MLCPM: A process monitoring framework for 3D metal printing in industrial scale. *Computers & Industrial Engineering*, 2018. 124: p. 322-330.
- [43] Imani, F., et al., Layerwise In-Process Quality Monitoring in Laser Powder Bed Fusion. 2018.
- [44] Yao, B., et al., Multifractal Analysis of Image Profiles for the Characterization and Detection of Defects in Additive Manufacturing. *Journal of Manufacturing Science and Engineering*, 2018. 140(3): p. 031014-031014-13.
- [45] Imani, F., et al., Process Mapping and In-Process Monitoring of Porosity in Laser Powder Bed Fusion Using Layerwise Optical Imaging. *Journal of Manufacturing Science and Engineering*, 2018. 140(10): p. 101009101009-14.
- [46] Montazeri, M., et al., In-Process Monitoring of Material CrossContamination Defects in Laser Powder Bed Fusion. *Journal of Manufacturing Science and Engineering*, 2018. 140(11): p. 111001-111001-19.
- [47] Sedaghati, A. and H. Bouzary, A study on the effect of cooling on microstructure and mechanical properties of friction stir-welded AA5086 aluminum butt and lap joints. *Proceedings of the Institution of Mechanical Engineers, Part L: Journal of Materials: Design and Applications*, 2017: p. 1464420717726562.
- [48] Igbelina, C., *The Synergistic Integration of Mass Customization, Parametric Design and Additive Manufacturing: A Case of Personalized Footwear*. 2018 (Doctoral dissertation, The University of Texas at San Antonio).
- [49] Attoye, S., E. Malekipour, and H. El-Mounayri, Correlation Between Process Parameters and Mechanical Properties in Parts Printed by the Fused Deposition Modeling Process. in *Mechanics of Additive and Advanced Manufacturing*, Volume 8. 2019. Cham: Springer International Publishing.
- [50] Malekipour, E., S. Attoye, and H. El-Mounayri, Investigation of Layer Based Thermal Behavior in Fused Deposition Modeling Process by Infrared Thermography. *Procedia Manufacturing*, 2018. 26: p. 1014-1022.
- [51] Ebrahimpour, A., et al., Experimental Measurement and Numerical Simulation of Temperature Distribution and Thermal History During Friction Stir Welding of Pure Copper Joints. *Journal of Mechatronics*, 2014. 2(2): p. 113-118.
- [52] Malekipour, E., A. Tovar, and H. El-Mounayri, Heat Conduction and Geometry Topology Optimization of Support Structure in Laser-Based Additive Manufacturing. in *Mechanics of Additive and Advanced Manufacturing*, Volume 9. 2018. Cham: Springer International Publishing.
- [53] Lee, S.H., Park, W.S., Cho, H.S., Zhang, W. and Leu, M.C., . A neural network approach to the modelling and analysis of stereolithography processes. *Proceedings of the Institution of Mechanical Engineers, Part B: Journal of Engineering Manufacture*, 2001. 215(12), pp.1719-1733.