



Fuzzy Controller for Efficiency Maximization of Induction Motors Connected to Islanded Network Powered By Wind Turbine Generation Using Optimum Constant Ratios of V/Hz and V/Hz^3

Muhammad M.A.S. Mahmoud

EasyChair preprints are intended for rapid dissemination of research results and are integrated with the rest of EasyChair.

November 7, 2021

Fuzzy Controller for Efficiency Maximization of Induction Motors Connected to Islanded Network Powered By Wind Turbine Generation Using Optimum Constant Ratios of V/Hz and V/Hz³

Muhammad M. A. S. Mahmoud
Independent Researcher
Cairo , Egypt
mmanar@yahoo.com

Abstract— In the remote area or offshore electrical installation, efficient power network is required. In many application wind turbine farm is used and operated isolated from the grid. In such cases, the frequency can be fluctuated with high range. This can affect the induction motor torque and efficiency. Typical solution for such problem is to use DC link to control the frequency. This method is costly and consume high power losses. The purpose of this paper is to design fuzzy controller for the induction motor to deliver the motor at the required torque and at highest possible efficiency. For that, combined fuzzy motor controllers based on linear dependency (V/Hz) and cubic dependency (V/Hz³) are developed for LV induction motor. The fuzzy controller receives frequency signal as input from the network and estimate the required firing angle of a full-wave thyristor circuit that receives power from the wind turbine and connected in series with the induction motor to control the voltage at motor terminal. Fluctuation of the power supply frequency during the starting and running condition of the motor are considered in the fuzzy controller design to select the optimum applied voltage to the motor for both cases. MATLAB Simulink is used to simulate and test the controller and the motor operation during the starting and running for the full applicable range of frequency. The output of the simulation results show the designed controller is fast and accurate. Comparison between the obtained results and the DC link method results is provided. From this comparison it was noticeable that at all input power range, the efficiency of the pump-motor system is considerably improved by using the proposed fuzzy controller. The minimum gain in the efficiency is 16.67% occurs at 800-Watt input power.

Keywords—induction motor; fuzzy controller; efficiency improvement ; Wind turbine generation ; islanded network

I. INTRODUCTION

Induction motor is one of the most widely used all over the world, it is one of the best for the industry purpose because of its simple robust construction, high efficiency and good power factor. The constant V/Hz control method is considered when constant speed is not essential for motor load function. In this case, the control scheme is implemented at the cost of decrease the efficiency and performance of the motor. [1]

In the V/Hz control method, the voltage - current ratio is always tried to be maintained constant. In [2], three-phase voltage source inverter (VSI) with speed control method is used. The author has varied the frequency and amplitude of

frequency of VSI to maintain the V/Hz ratio constant and drive the motor at reference speed.

Open Loop V/Hz Method Control gained high usage in regards to the methods used for controlling speed. This type of motor control is widely used in industry because of its appreciated advantages such as; low costs, simplicity in operation and immunity to error of the feedback signal [3].

In [4], DC link Converter method is used to control the frequency. With the cubic dependency between voltage and frequency for the induction motor control, a higher speed is obtained, and that leads to a better motor efficiency, in comparison with the case of linear V/Hz control. Open-loop Controller was used to obtain the results.

None of the work in [2] - [4] tried to improve the efficiency of the controlled motor. But actually, the methods that were used to control V/f ratio, such as VSI with PI controller in [2], PWM in [3] and DC link in [4] have introduced high losses to, and hence reduces the entire system efficiency.

Fuzzy Logic Techniques have demonstrated their enhanced performance in different applications of electrical power network: The technique is successfully used in enhancement the operation process [5] [6]. Also fuzzy logic is widely used in many control application [7], [8]. Since fuzzy logic has proven its performance in many domains of science and technology, it also found that fuzzy logic is suitable tool to be used in this research.

In this paper, open-loop voltage-frequency dependency controller is developed using simple full wave thyristor circuit to reduce the losses of the controller for Induction Motor(s) Connected to islanded wind turbine generation Source (Fig. 1). The firing angle required for the controller is tuned by fuzzy logic controller to achieve maximum possible efficiency for the system using voltage-frequency techniques, V/f and V/f³

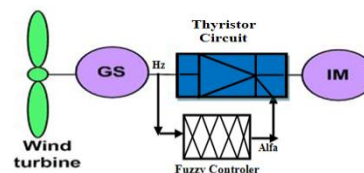

Fig. 1. System with voltage- frequency dependency fuzzy controller

In Section II, System Modeling is discussed including the modeling of power supply, motor characteristics during starting and running conditions and then the model of mechanical load connected to the motor. In Section III, the design procedure of the proposed fuzzy controller is discussed, and built in MATLAB Simulink. In Section IV, the induction motor operation performance with the fuzzy controller is discussed and evaluated. Conclusion for the complete work is given in Section V.

II. SYSTEM MODELING

A. Power supply:

The wind turbine and its induction generator are modelled as simple variable frequency power supply with constant line voltage of 400 Volt. This regulated voltage can be achieved using transformer with automatic tap changer connector at the output terminal of the wind turbine generator. The power supply from the wind turbine generator is connected to the load (induction motor) through full-wave thyristor circuit.

B. Induction Motor:

The motor load is modelled as 5.5kW induction motor with the following parameters:

- Nominal Apparent Power = 6.962 VA, Line to line Voltage = 380V, Frequency = 50Hz
- Stator Resistance = 0.71 Ohm, Stator Inductance = 4.5 mH
- Rotor Resistance = 0.728 Ohm, Rotator Inductance = 4.5 mH
- Mutual Inductance: 93.75 mH
- Moment of Inertia = 0.2, kg.m²,
- Friction Factor = 0.051 N.m.s, Pole pairs = 3

C. Mechanical Load (Pump)

The pump load has been modelled by the following Speed/Torque and respective Speed/Power curves:

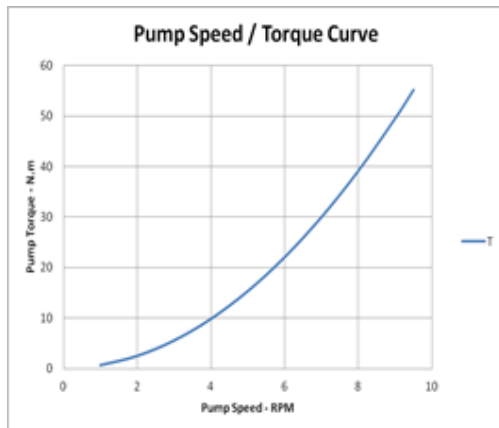

Fig. 2. Pump Speed/Torque

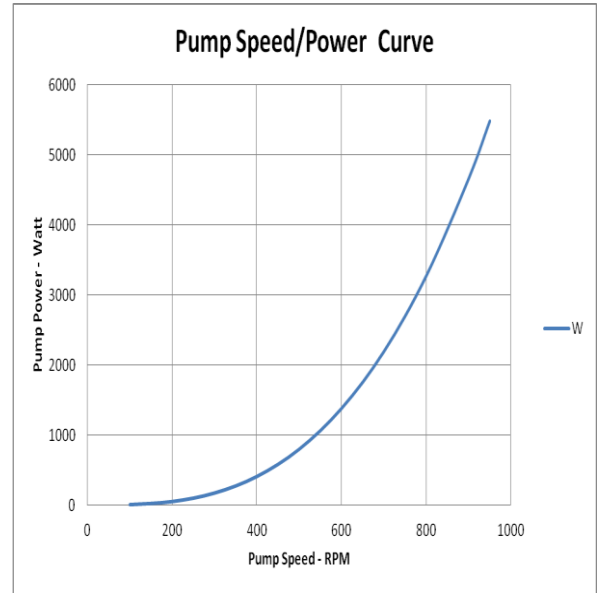

Fig. 3. Pump Speed/Power

D. Motor Starting and running Characteristics:

Running and the optimum voltage frequency dependent characteristic has been analyzed in [4], for the maximum efficiency. The analyses recommended the following characteristics for starting and running cases:

a. Starting characteristic:

Motor starting is based on V/Hz characteristic with slope 30/5.

b. Running characteristic:

- In the range of 5 Hz and 10 Hz, it is imposed on the motor to go on the characteristic determinate from the motor datasheet, which is:

$$V/Hz_1^3 = 0.0025 \cdot 3 \cdot f^3 + 30 \quad (1)$$

- In the range of 10 Hz and 20 Hz the motor is imposed to pass on characteristic given by:

$$V/Hz_2^3 = 0.005 \cdot 3 \cdot f^3 + U_{10Hz}. \quad (2)$$

- In the range of 21 Hz and 25 Hz, motor is imposed to pass on characteristic:

$$V/Hz_3^3 = 0.006 \cdot 3 \cdot f^3 + U_{20Hz}. \quad (3)$$

- Above 25Hz, the characteristic is based on

$$V/Hz_2^3 = 0.0025 \cdot 3 \cdot f^3 + U_{25Hz} \quad (4)$$

in parallel with:

$$V/Hz_1^3 = 0.0025 \cdot 3 \cdot f^3 + 30 \quad (5)$$

(Determined from datasheet values).

Where, U_{10Hz} , U_{20Hz} and U_{25Hz} represents the voltage at 10 Hz, 20 Hz and 25 Hz respectively.

The optimum voltage-frequency characteristic for the maximum efficiency illustrated in Fig. 5.

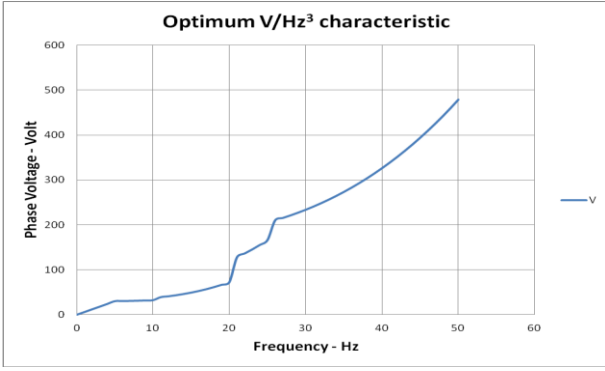

Fig. 4. Optimum V/Hz^3 Characteristic

III. FUZZY CONTROLLER:

In order to build fuzzy controller with input signal “frequency” and output signal “firing angle- α ” to tune the motor applied voltage to the corresponding input signal frequency based on the optimum voltage-frequency characteristic for the maximum efficiency, it is important to develop a direct relation between “firing angle- α ” and the frequency based on the optimum voltage-frequency characteristic.

A. Step 1:

The effect of single-phase full-wave circuit is considered to determine the size load voltage and current at different firing angle “ α ”. The general formulas for the r.m.s. values of the current (I_{load}) and the voltage (V_{load}) across a load, comprise of inductance in series with resistance, controlled by single-phase full-wave circuit are given in [9]. These formulas are as following:

$$I_{Load} = \frac{\sqrt{2} \times V_{source}}{z} \left[\frac{1}{\pi} \int_{\alpha}^{\beta} \{ \sin(\omega t) - \sin(\alpha t) e^{(r/l)} (\alpha / \omega t) \} dt \right]^{1/2} \quad (6)$$

$$V_{Load} = V_{source} \left[\frac{1}{\pi} \left(\beta - \alpha + \frac{\sin(2\alpha)}{2} - \frac{\sin(2\beta)}{2} \right) \right]^{1/2} \quad (7)$$

Where:

$\omega = 2\pi f$ radian/second

α = Firing angle

β = Extinction angle (cut-off angle)

$\theta = \tan^{-1}(l/r)$

l = Load Inductance

r = Load Resistance

t = Time

z = Load impedance.

Since the conducting angle $\delta = \beta - \alpha$ cannot exceed π , then the firing angle α will not be less than θ and hence the control range of the firing angle is

$$\pi \geq \alpha \geq \theta \quad (8)$$

To maximize the firing angle range for better voltage control, a resistive load may be inserted in parallel to the motor to minimize the value of $\theta \approx 0$.

For maximum power transferred to the motor, the maximum conducting angle is considered. Therefore, the value of the controlled voltage corresponding to each firing angle α can be calculated assuming that $\alpha = \pi/2$ and $\beta = \pi$

The value of the controlled voltage with respect to firing angle at different frequency values can be found by practical and fast method using the MATLAB Simulink tool [10]. Fig. 5 illustrates the proposed model that has been used to evaluate the value of the controlled voltage for different value of firing angles “ α ”.

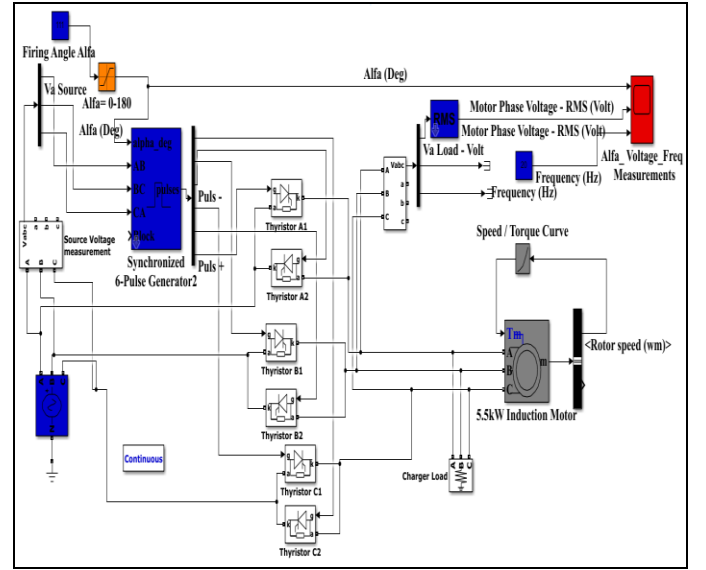

Fig. 5. Proposed Model to calculate the controlled voltage for different value of firing angles α

Using the Simulink model shown in Fig.6, direct relations between firing angle “ α ” and the “frequency” based on the optimum voltage-frequency characteristic given in Section 2 (D) is illustrated in Fig.7 and Fig.8:

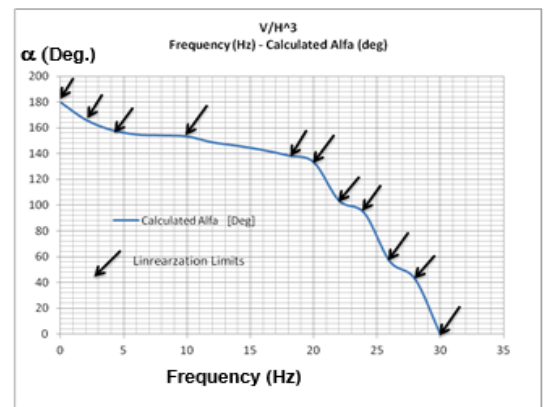

Fig. 6. Relations between firing angle “ α ” and the “frequency based on V/Hz^3 Characteristic

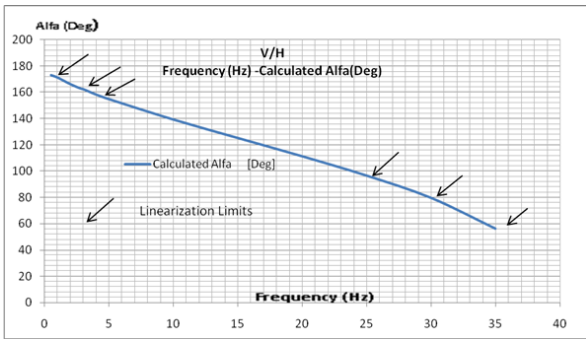

Fig. 7. Relations between “firing angle- α ” and the “frequency” based on V/Hz Characteristic.

B. Step 2:

In this step, the “ α -Frequency” curves obtained in Step 1 is linearize.

The resultant curves related to V/Hz and V/Hz^3 are divided into M and N sections respectively (boundaries are marked in yellow in the result tables), which can be approximated to the nearest linear sections. Two Fuzzy controllers are built. One for V/Hz^3 “ α -Frequency” curve and another one for V/Hz “ α -Frequency” curve. The first Fuzzy Controller consists of M fuzzy sub-controllers, each representing one section, and the second controller consists of N sub-controllers each representing one section as well.

The resultant output of each fuzzy sub-controller will be equal to the respective linearized section using the following functions for fuzzy implication process:

- Mamdany engine.
- Triangle type for Membership functions.
- Product for And.
- Max for Or.
- Min for Implication
- Proportional for Aggregation.
- Largest of Maximum for Defuzzification
- With Fuzzy rule:

If (Frequency) is $mf(input)^a$ Then (α) is $MF(output)^b$ (9)

where,

$a = 1, 2, \dots, K$ (fuzzy membership function number)

$b = K - a + 1$ (fuzzy membership function number)

and K is the number of the fuzzy membership function.

Based on the above fuzzy setup, the following Fig. 8 illustrates a typical input/output for a fuzzy sub-controller related to V/Hz^3 with input frequency range of 28-30 Hz and output firing angle “ α ” range of 0- 42.8 Deg. The results prove the validity of fuzzy sub-controller to represent the linearized section for this specific range.

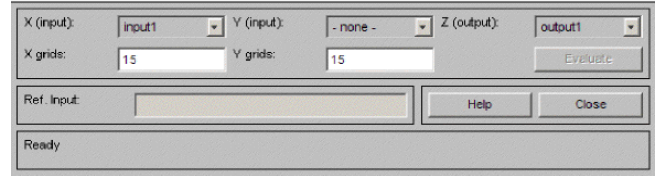
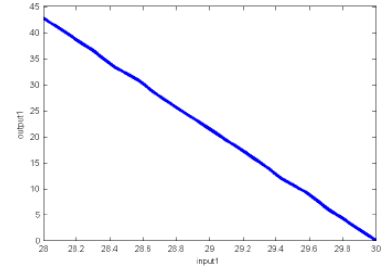

Fig. 8. Typical input/output for a fuzzy sub-controller related to V/Hz^3

C. Step 3:

Simulink toolbox is used to build V/Hz^3 fuzzy controller for the system illustrated in Fig 1. Full simulation is carried out to operate the induction motor from frequency range 0-50 Hz. The motor is assumed initially under running condition (Slip = 0.02), as motor starting was made on V/Hz characteristic not on V/Hz^3 . The result is summarized in Table I:

TABLE I. RESULTS OF V/Hz^3 FUZZY CONTROLLER FOR THE MOTOR-PUMP SYSTEM

Source Phase Voltage [V]	Source Frequency [Hz]	Required Controlled Phase Voltage [V]	Calculated α [Deg]	Measured α [Deg]	Measured of Controlled Phase Voltage [Volt]	Measured % Efficiency
231	0	0	180	rotor locked	rotor locked	rotor locked
231	2	12	166.4	rotor locked	rotor locked	rotor locked
231	4	24	158.5	158.6	23.82	11.07
231	6	30.54	155	156	26.56	29.25
231	8	31.28	154.3	155.2	29.59	47.27
231	10	32.5	153.5	153.5	32.54	49.91
231	12	41.15	148.9	149.7	39.36	55.5
231	14	46.22	146.2	145.8	47.07	60.38
231	16	52.98	142.9	142.4	53.89	60.2
231	18	61.66	138.7	138.8	61.2	64.88
231	20	72.5	133.5	133.5	72.49	67.59
231	22	136.4	103.7	103.7	136.3	68.66
231	24	155.44	94	94.1	155.2	70.21
231	26	210	56.7	56.7	209.9	64.9
231	28	221	42.8	42.8	221	69.11
231	30	233.8	0	0	230.2	71.3
231	35	233.8	0	0	230.2	73.75
231	40	233.8	0	0	230.2	70.85
231	45	233.8	0	0	230.2	66.42
231	50	233.8	0	0	230.2	61.7

D. Step 4:

In this step, Simulink toolbox is used to build V/Hz fuzzy controller instead of V/Hz^3 . The motor is assumed initially at Stand Still (SS) where, Slip =1. The result is summarized in Table II.

TABLE II. RESULTS OF V/Hz FUZZY CONTROLLER FOR THE MOTOR-PUMP SYSTEM

Source Phase Voltage [V]	Frequency [Hz]	Required Controlled Phase Voltage [Volt]	Calculated α [Deg.]	Measured α (Deg.)	Measured of Controlled Phase Voltage [Volt]	Starting Time [sec]	V/Hz SS % Efficiency
231	0.5	3	173.1	rotor locked	rotor locked	rotor locked	rotor locked
231	1	6	171.	rotor locked	rotor locked	rotor locked	rotor locked
231	2	12	166.3	rotor locked	rotor locked	rotor locked	rotor locked
231	2.8	16.8	163	17.64	162.5	1.3	10.9
231	3	18	162.5	161.8	18.53	1.2	10.3
231	4	24	158.4	158.4	24.16	1.05	10.4
231	5	30	154.9	154.9	30.12	1	14.6
231	10	60	139.4	141.5	55.7	0.66	37
231	15	90	125.4	91.56	124.7	0.35	51.6
231	20	120	111.5	110.2	122.9	0.22	63
231	25	150	96.8	96.8	150.1	0.138	72
231	30	180	79.9	79.9	180	0.12	77
231	35	210	56.5	56.5	210.1	0.1	75
231	40	230	0	0	230.2	0.12	70.9
231	45	230	0	0	230.2	0.2	66.4
231	50	230	0	0	230.2	0.33	61.7

E. Step 5:

From Step 3 and Step 4, the efficiency at steady state can be compared between V/Hz³ and V/Hz controller. The result is given in the following Fig.9 and Fig.10.

From Fig.9, it can be noticed that the maximum efficiency alternates between both controllers. From Frequency 2.8-Hz to 23.5-Hz, maximum efficiency can be achieved by V/Hz³ controller. However, from Frequency 23.5-Hz to 37-Hz, maximum efficiency can be achieved by V/Hz controller. For the frequency range greater than 37-Hz, the firing angle for both controllers reaches its minimum (zero), and the applied voltage to the motor reaches its maximum value (230-V), therefore, both controllers have the same results for the efficiency. Fig.10 illustrates the envelopment of the net maximum efficiency achieved by both controllers.

In order to build the required fuzzy controller, following criteria must be considered, as well as to build the controller:

- The Controller must switch to V/Hz characteristic during the motor starting.
- For maximum efficiency:
 - The controller must be switched to V/Hz³ for frequency less than 23.5-Hz.
 - The Controller must be switched to V/Hz in the frequency range 23.5-Hz to 37-Hz.

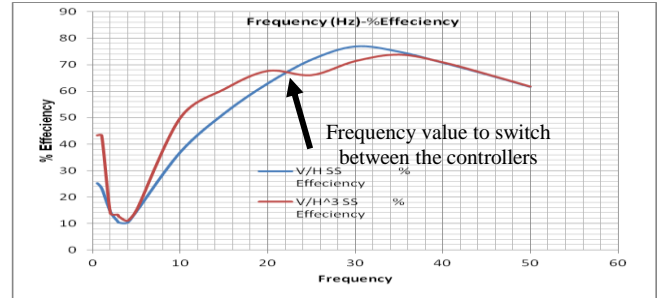

Fig. 9. Efficiency at steady state achieved by both controllers V/Hz and V/Hz³

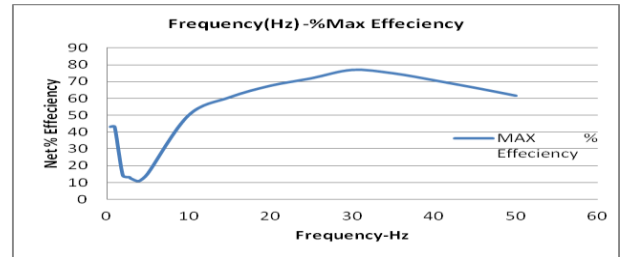

Fig. 10. . Envelopment of the net maximum efficiency achieved by both controllers.

Fig. 11 illustrates the proposed fuzzy controller presented in MATLAB Simulink to achieve the maximum efficiency for the operation of the pump-motor at any frequency.

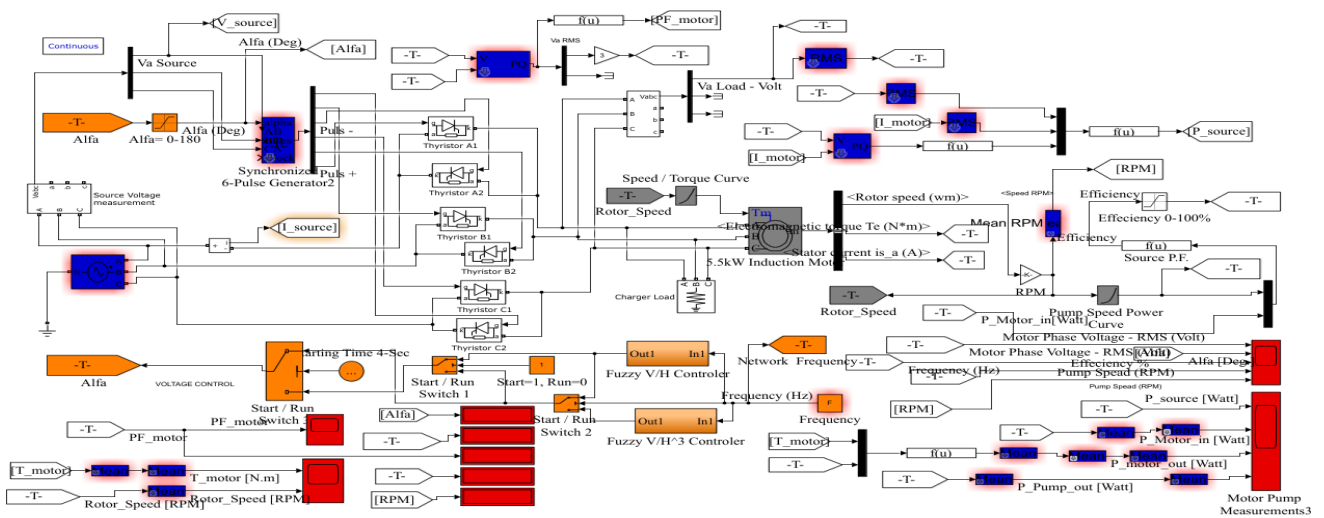

Fig. 11. Proposed fuzzy controller to achieve the maximum efficiency for the operation of the pump-motor at any frequency

IV. RESULTS AND DISCUSSION

Simulink model is used to determine the main pump – motor characteristics such as “Efficiency”, “Power”, “Losses”, “Power Factor”, “Starting Time” and “Protection”, for the effective frequency range from 2.8-Hz to 35-Hz. The result shall be illustrated and discussed hereinafter in this clause.

A. Efficiency:

Neglecting the losses in the thyristor circuit compared with the DC link method [11] [12], the Input power-efficiency curve obtained by full wave thyristor circuit fuzzy controller in this paper is compared with the result achieved in [4], using DC link controller. Fig.12 illustrates the results.

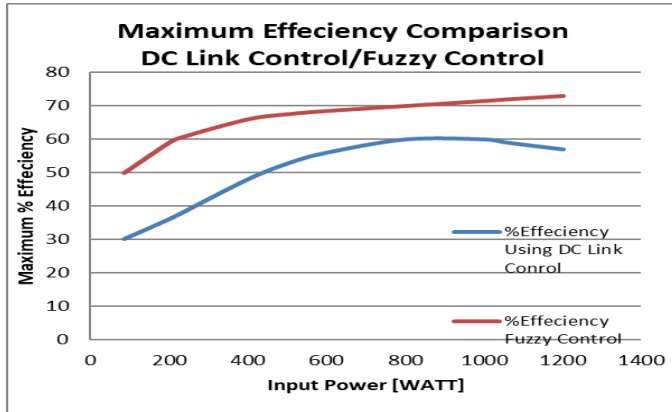

Fig. 12. Comparison between Thyristor full wave controller results and DC link controller results.

From the result, it is noticeable clearly that at all input power range, the efficiency of the pump-motor system is considerable improved by using the proposed fuzzy controller. The minimum gain in the efficiency is 16.67% occurs at 800-Watt input power.

B. Power Factor

TABLE III. MOTOR POWER FACTOR RESULTS

Freq. [Hz]	V/Hz SS Power Factor	V/Hz ³ SS Power Factor	MAX Efficiency
2.8	0.46	0.47	0.47
3	0.43	0.45	0.45
4	0.365	0.363	0.365
5	0.32	0.36	0.36
10	0.285	0.654	0.654
15	0.264	0.717	0.717
20	0.294	0.734	0.734
25	0.353	0.216	0.353
30	0.397	0.2184	0.397
35	0.423	0.337	0.423

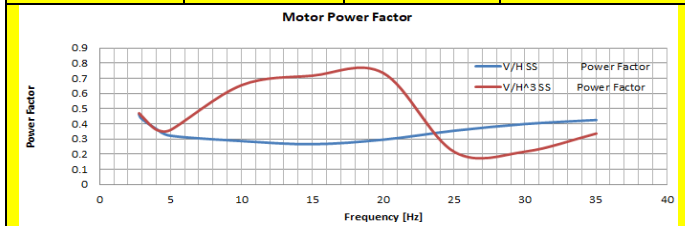

Table III illustrates the motor power factor in case of applying V/Hz and V/Hz³ controller. Comparing the curves of Table III with Fig. 10, it can be concluded that the maximum efficiency envelop is tracing the maximum power factor obtained from both controllers.

C. Input /Out Power

“Motor Input Power”, “Motor Output power” and “Pump Output power to the Pump” are illustrated in Tables IV, V and VI respectively.

For the “Motor Input Power”, it is noticeable that in the effective frequency range from 2.8Hz to 35 Hz, controller has operated the motor at minimum power that can be obtained by either V/Hz or V/Hz³. This result is consistent with Section IV (B) as the motor losses were also minimised due to the improvement of the motor power factor (See Table VII). However, for the “Motor Output Power” curve (Table V) shows that the less power become available for the mechanical load and consequently the pump has provided less power output for pumping the fluid (Table VI).

Analyzing the Power results, it was found that the reduction in the “Motor Input Power” along the effective frequency range is more effective than the increase in “Motor Output Power” and “Pump Output Power”. Table VIII illustrates the “Net Saving in Pumping System power” that causes the improvement of the pumping system efficiency, using combined fuzzy controller of V/Hz and V/Hz³, where:

$$\text{Efficiency} = \text{Pump Output Power} / \text{Motor Input Power} \quad (10)$$

Since the reduction in the Motor Input power is more than the increase of the Pump Output power, so the resultant efficiency is increased. The increase of the “Net Saving in Pumping System power” is constant with the power factor results Table III.

TABLE IV. MOTOR INPUT POWER RESULTS

Freq. [Hz]	V/Hz SS Input Power [WATT]	V/Hz ³ SS Input Power [WATT]	MAX Efficiency
2.8	32	27	0.47
3	34	30	0.45
4	46.2	44.7	0.365
5	60	41	0.36
10	140	86	0.654
15	328	234	0.717
20	617	500	0.734
25	1059.9	1184	0.353
30	1716.31	1899	0.397
35	2536.4	2600	0.423

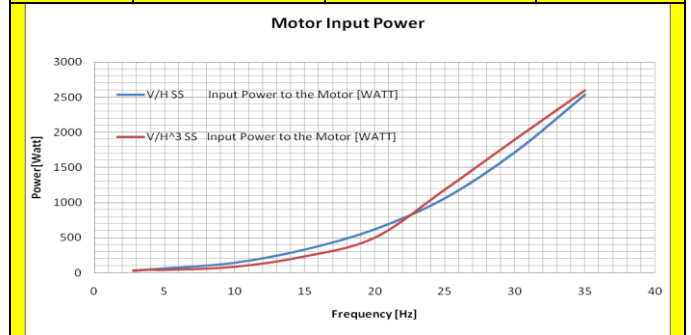

TABLE V. MOTOR OUTPUT POWER RESULTS

Freq [Hz]	V/Hz SS Output Power from the Motor [WATT]	V/Hz ³ SS Output Power from the Motor [WATT]	MAX Efficiency
2.8	3.45	3.4	0.47
3	4	3.9	0.45
4	7.2	7.1	0.365
5	11.5	11.1	0.36
10	70	58	0.654
15	213	178	0.717
20	478	412	0.734
25	896	916	0.353
30	1504	1548	0.397
35	2280	2305	0.423

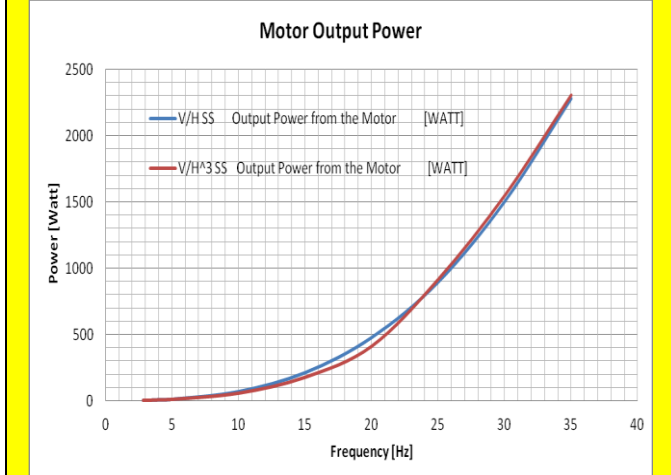

TABLE VI. PUMP OUTPUT POWER RESULTS

Freq [Hz]	V/Hz SS Output Power From Pump [WATT]	V/Hz ³ SS Output Power To Pump [WATT]	MAX Efficiency
2.8	3.41	3.39	0.47
3	3.67	3.65	0.45
4	4.95	4.93	0.365
5	6.75	6.3	0.36
10	49	43	0.654
15	167	142	0.717
20	393	343	0.734
25	763	781	0.353
30	1321	1353	0.397
35	1897	1914	0.423

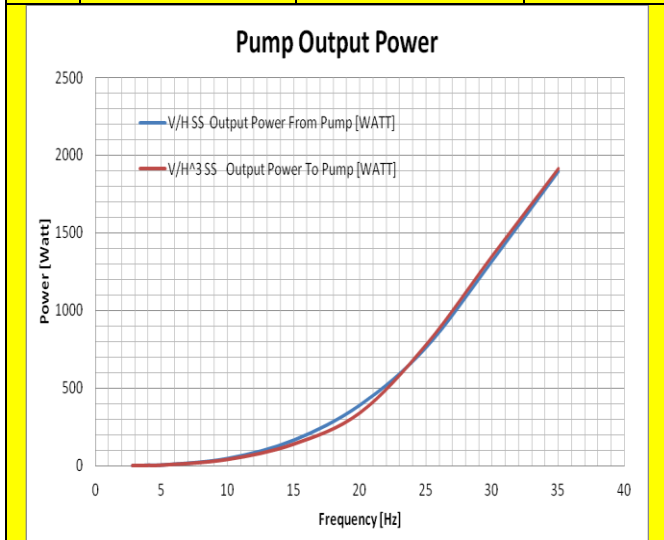

TABLE VII. MOTOR LOSSES RESULTS

Freq. [Hz]	V/Hz SS Motor Losses [Watt]	V/Hz ² SS Motor Torque [Watt]	MAX Efficiency
2.8	28.55	23.6	0.47
3	30	26.1	0.45
4	39	37.6	0.365
5	48.5	29.9	0.36
10	70	28	0.654
15	115	56	0.717
20	139	88	0.734
25	163.9	268	0.353
30	212.31	351	0.397
35	256.4	295	0.423

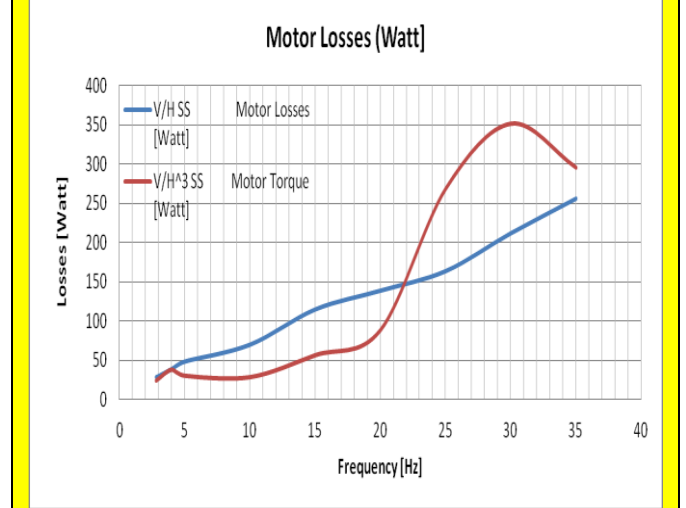
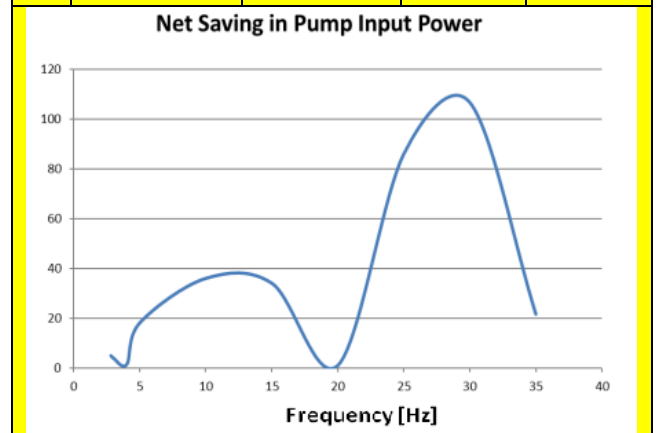

TABLE VIII. NET SAVING IN PUMPING SYSTEM POWER

Freq. [Hz]	Reduction in Motor Input Power	Increase in Motor Output Power	Increase in Pump Input Power	Net saving in Pumping Power
2.8	5	0.05	0.02	4.93
3	4	0.1	0.02	3.88
4	1.5	0.1	0.02	1.38
5	19	0.4	0.45	18.15
10	54	12	6	36
15	94	35	25	34
20	117	66	50	1
25	124.1	20	18	86.1
30	182.69	44	32	106.69
35	63.6	25	17	21.6



D. Speed

Table IX summarizes the speed of the motor results from applying V/Hz and V/Hz³ controllers. A slight difference in the speed is observed between both mode of operation. This is actually due to the change in the applied voltage that causes slight change in the operating torque value, and normally this do not result effective change in the speed of the Induction motors.

TABLE IX. MOTOR-PUMP SPEED

Freq. [Hz]	V/Hz SS RPM	V/Hz ³ SS PM	MAX Efficiency
2.8	53	53	0.47
3	57.5	57.5	0.45
4	77.2	77.2	0.365
5	97.2	96.2	0.36
10	195	181	0.654
15	294.8	274.7	0.717
20	393.4	371.9	0.734
25	491.3	495.3	0.353
30	589.5	595	0.397
35	688.5	691	0.423

E. Starting Current:

Starting current time for the motor based on V/Hz characteristic is shown in the Fig.13. This data is important for the motor protection, as it can indicate the locked rotor case at different frequencies. Accordingly, the stall protection setting has to be programmed

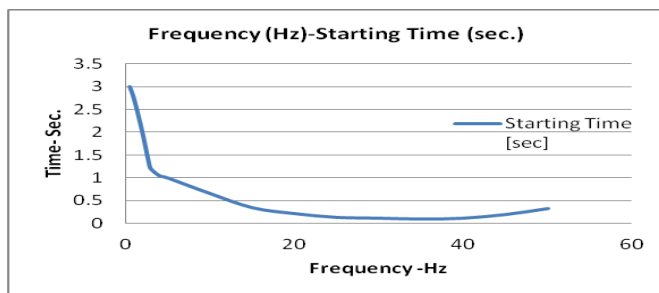

Fig. 13. Comparison Motor Starting Time Results

F. General discussion on the results:

Constant volts per hertz (V/Hz) control is the most popular scalar control scheme that varies the terminal voltage in proportion to the supplied frequency to maintain the air-gap flux at approximately the rated V/Hz ratio. However, all the non-idealities including stator resistance, leakage inductance, core losses and rotor slip cause the constant V/Hz control to exhibit worse performance at low frequency [13]. This was clearly illustrated in the result in Tables for low frequency values up to 4-Hz approximately.

In V/Hz method, the motor operates at approximately constant torque mode. Therefore, the slip speed of the rotor is always small and the rotor continuously operates in the optimum torque condition, and the slip is assumed to be constant at any frequency value.

The constant V/Hz control is usually derived from the simplified steady-state equivalent circuit shown in Fig. 14.

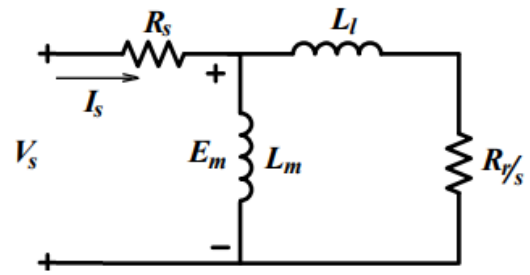

Fig. 14. Simplified steady-state equivalent circuit of induction machine

The constant V/Hz control is usually derived from the simplified steady-state equivalent circuit shown in Fig. 14.

The stator resistance R_s is assumed to be zero and the stator leakage inductance L_{ls} is lumped with rotor leakage inductance L_{lr} (referred to the stator) into the total leakage inductance ($L_l=L_{ls}+L_{lr}$). The magnetizing branch where the air gap flux is produced is moved before the total leakage inductance, yielding an approximation that $V_s = E_m$ [14].

For V/Hz³, at low frequency and low voltage, the inductance of L_m is relatively low. Accordingly, the reactive power consumed by L_m is relatively, therefore, the motor has low power factor at this interval (Table III).

As frequency increased, the voltage need, the reactance of L_m is increased linearly, and the reactive power consumed by the system is decreased. This Justify the power factor improvement that presented in Table III up to 11-Hz.

As the frequency increases further, the voltage must be increased parabolically to satisfy constant V/Hz³. This will cause the air gap flux to start saturation, and L_m reactance rate of increase with frequency start to reduce. Therefore, the power factor remains increasing up to 20-Hz but with less rate of increase.

After 20-Hz, the gap is saturated, and any further Also at the same time with the frequency increase, this makes the reactance of L_m is constant and independent any more on the frequency. In the same time L_{lr} reactance still increased with frequency increase, Therefore, the reactive power consumed by L_m starts to increase relatively. This justify why the power factor starts to reduce after 20-Hz up to 26-Hz.

After 26 Hz, by further increase of the applied voltage the motor, L_l reactance starts to saturate and this justify the slight improvement of the power factor after 26-Hz.

However, for the power V/Hz control, the power facto does not follow the same trend of V/Hz³ because induction motors winding design and air gap deign consider constant V/Hz ration for the full operating range without flux saturation in the inductance or air gap. This justifies the different trend of the power factor between V/Hz³ and V/Hz.

The above power factor analysis is consistent with the loses results (Table III and Table XII). As it can be easily observed that, for high power factor, the losses value is low, and vis versa.

V. CONCLUSION

In this paper, in order to improve the total efficiency of islanded network that powered by wind turbine generators, new approach was followed. Instead of the traditional approach of improving the wind turbine efficiency, the paper focused on improving the efficiency of the motor loads connected to islanded network using fuzzy open-loop controller.

The proposed open-loop fuzzy controller presented in this paper shows an efficient, fast and accurate technique in controlling the motor to operate at maximum efficiency for any frequency value from 0-Hz up to 5-Hz. As seen from the overall structure of the controller, it utilizes both V/Hz and V/Hz³ characteristics to achieve maximum efficiency for the induction motor within the effective frequency range from 2.8-Hz to 35-Hz.

Better efficiency has been achieved by using full-wave thyristor circuit control instead of DC link to control the voltage-frequency dependent characteristics. The effective reason that causes the improvement of the efficiency is mainly the improvement of the motor power factor.

This paper will bring the attention in the future work towards generalizing the motors-controllers, that are designed for variable frequency power source, to include both V/Hz and V/Hz³ characteristics, so that the optimum voltage-frequency dependent characteristic can be selected to achieve the minimum losses and maximum efficiency of the motor.

Harmonics is one important issues that need to be considered in the design of the controller and harmonics filter may be installed as needed. In addition to that, protection relays setting need to be checked for reliable operation of the motor.

REFERENCES

- [1] J. Clerk Maxwell, A Treatise on Electricity and Magnetism, 3rd ed., vol. 2. Oxford: Clarendon, 1892, pp.68-73.
- [2] Ranju Bharti, Madhav Kumar, B.M Prasad, "V/F Control of Three Phase Induction Motor," International Conference on Vision Towards Emerging Trends in Communication and Networking (ViTECoN); 2019.
- [3] M. H. V. Reddy and V. Jegathesan, "Open loop V/f control of induction motor based on hybrid PWM with reduced torque ripple," 2011 International Conference on Emerging Trends in Electrical and Computer Technology, Nagercoil, 2011, pp. 331-336.
- [4] A. Forcos, C. Marinescu, "Motor Pump Group Efficiency in a Wind Energy Pumped Storage System", Advanced Topics in Electrical

Engineering (ATEE), 2011 7th International Symposium, 12-14 May 2011 .

- [5] Muhammad M.A.S. Mahmoud "3-Phase Fault Finding in Oil Field MV Distribution Network Using Fuzzy Clustering Techniques", Journal of Energy and Power Engineering 7 (2013) 155- 161.
- [6] Muhammad M.A.S. Mahmoud, Zafar Qurbanov,"Review of Fuzzy and ANN Fault Location Methods for Distribution Power System in Oil and Gas Sectors," IFAC-PapersOnLine, Volume 51, Issue 30, 2018,Pages 263-267,ISSN 2405-8963, <https://doi.org/10.1016/j.ifacol.2018.11.298>.
- [7] Muhammad M.A.S. Mahmoud, " Accurate Reactive Power Controller and Power Factor Correction Using Fuzzy Logic" Journal of Energy and Power Engineering 7, 1163-117.
- [8] Manar M. Sabry, MA Al-shaher, AS Saleh, "Reactive Power Control and Power Factor Improvement Using Fuzzy Controllers", Engineering Intelegent System . Page 47-53, 2006 CRL Publishing Sysyem.
- [9] MATLAB 2019(a), SIMULINK, The MathWorks, Inc.
- [10] Muhammad Harunur Rashid, Power Electronics Circuit, Devices and Applications, *Prentice Hall Inc*, NJ, 1988.
- [11] Muhammad M.A.S. Mahmoud, "Efficiency Improvement for Motor-Pump Set of a Wind Energy Pumped Storage System Using V/F^X Fuzzy Controller, International Journal of Energy, Issue 2, Vol. 6, 2012.
- [12] Muhammad M.A.S. Mahmoud "New Area in Fuzzy Applications " Book Chater 17, Ffuzzy Controllers Recent Advances in Theory and Application, ISBN 978-953-51- 0759-0, PP 385 – 440. INTECH, , 2012.
- [13] B. W. Williams and T. C. Green, "Steady-state control of an induction machine by estimation of stator flux magnitude," Proc. Inst. Elect. Eng. B, vol. 138, pp. 69–74, Mar. 1991.
- [14] Zhe Zhang, Student Member, Yiqi Liu, Ali M. Bazzi, "An improved high-performance open-loop V/f control method for induction machines", IEEE Applied Power Electronics Conference and Exposition (APEC) -2017. DOI: [10.1109/APEC.2017.7930757](https://doi.org/10.1109/APEC.2017.7930757)



Muhammad M.A.S. Mahmoud, Egyptian, Received the B.S. degree in Engineering from Cairo University and the M.Sc. degree from Kuwait University. First Ph.D. degree from Transilvania University of Brasov, Romania in IT and Computer. Second PhD Degree in Electrical Power system and Machine, Cairo Univ. Egypt. He received a position of "Professor" om 2018. His current research interests in Fuzzy and Artificial Neural Network Techniques application include power delivery, protection reliability, control, safety, building automation and energy management. Prof. Dr. Muhammad is of IEEE Member in 1999, IEEE Senior Member (SM) since 2001 and TFS –IEEE Reviewer 2016.